

INSTALLATION & USER MANUAL

EVC





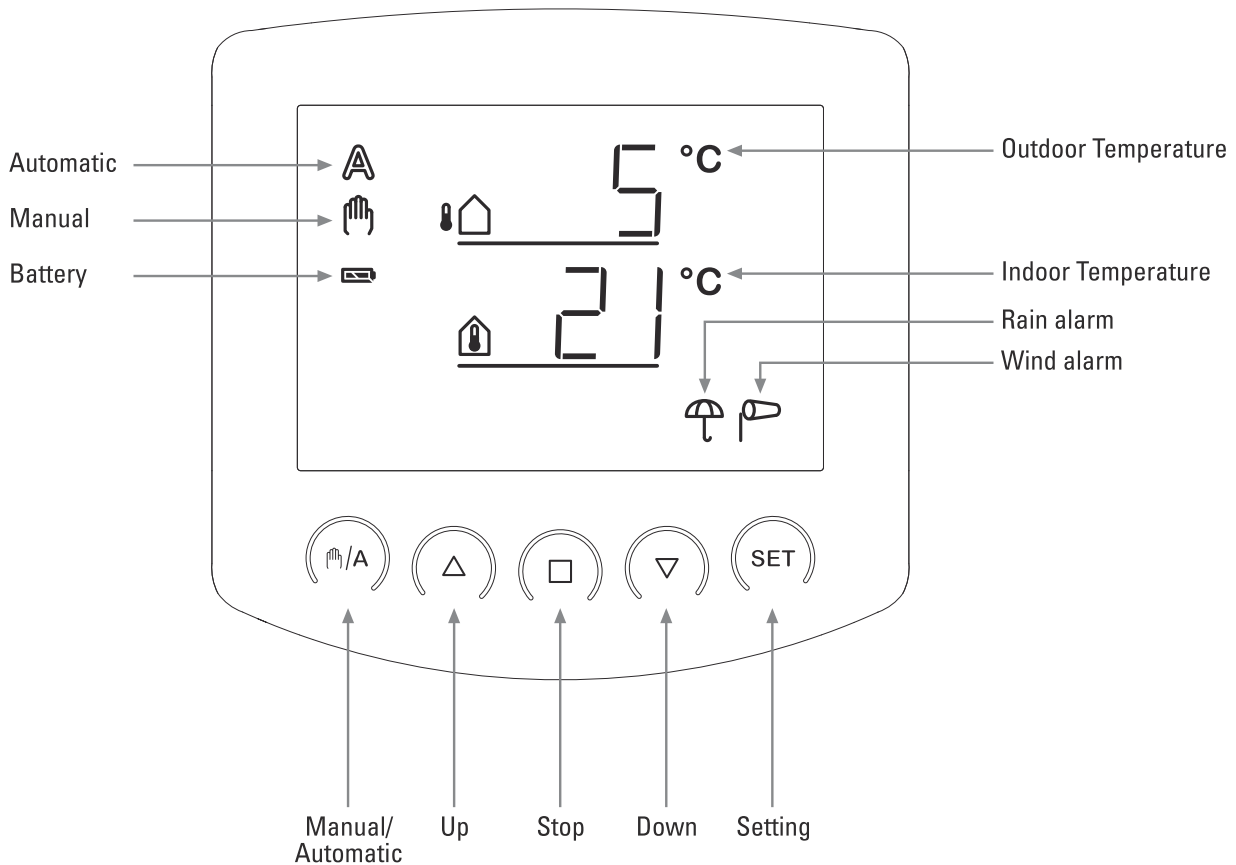

RAIN & TEMPERATURE CONTROL UNIT



OVERVIEW



The basic position of the operating unit of the control system displays the current outdoor temperature (upper line) and the indoor temperature (lower line) as well as the function mode (automatic or manual), the battery load and the current alarm messages for rain or wind. The meteorological data are updated once per minute (and in case of a keystroke).

-  Outdoor temperature
-  Indoor temperature
-  Battery symbol (indicates the charge status of the battery) - full
-  - half full
-  - empty
-  Automatic mode activated

OVERVIEW



Manual mode activated. The connected drive mechanism was operated manually (with arrow keys) or /▲ key was pressed. Thus, the automatic functions are deactivated, there is no control in terms of temperature. The safety functions rain alarm and wind alarm are still activated. The control is in manual mode until you change to automatic mode with /▲ key.



Rain alarm. The window is closed, manual operation is blocked. The rain protection function may be turned on and off in the automatic settings.



Wind alarm. The window is closed, manual operation is blocked. The wind protection function may be set up or turned off in the automatic settings.

Manual operation

Manual control as well as the presetting of the automatic functions and the basic setting of the connected shading is accomplished with the keys of the operating unit.

Move window manually



Up



Stop



Down

The connected window may be manually operated with the keys , and . The arrow keys are provided with a time automatic. By short pressing (less than 1 second), the window may be exactly positioned. If the key is pressed more than 1 second, the drive mechanism moves automatically to the final position. If you press , the drive mechanism stops.





In case of rain or wind alarm, the manual operation is blocked.

OVERVIEW

Switch between manual and automatic



Manual/automatic

Key /A switches between automatic mode (display ) and manual mode (display ). After the manual operation with the keys Δ , \square or ∇ , the control system is in manual mode. The automatic functions then are deactivated, there is no control in terms of temperature. With key /A, the control is reset to automatic (display ).

If the next automatic command is an opening command, then the control closes the window at first (4-minute reference movement). After that the opening position is initiated.

TECHNICAL DATA

CODE	EVC (Weather Station)
VOLTAGE (INPUT)	230VAC
VOLTAGE (OUTPUT)	230VAC
OUTPUT CURRENT	4A
PROTECTION CLASS	IP44
DIMENSIONS	96x77x118mm

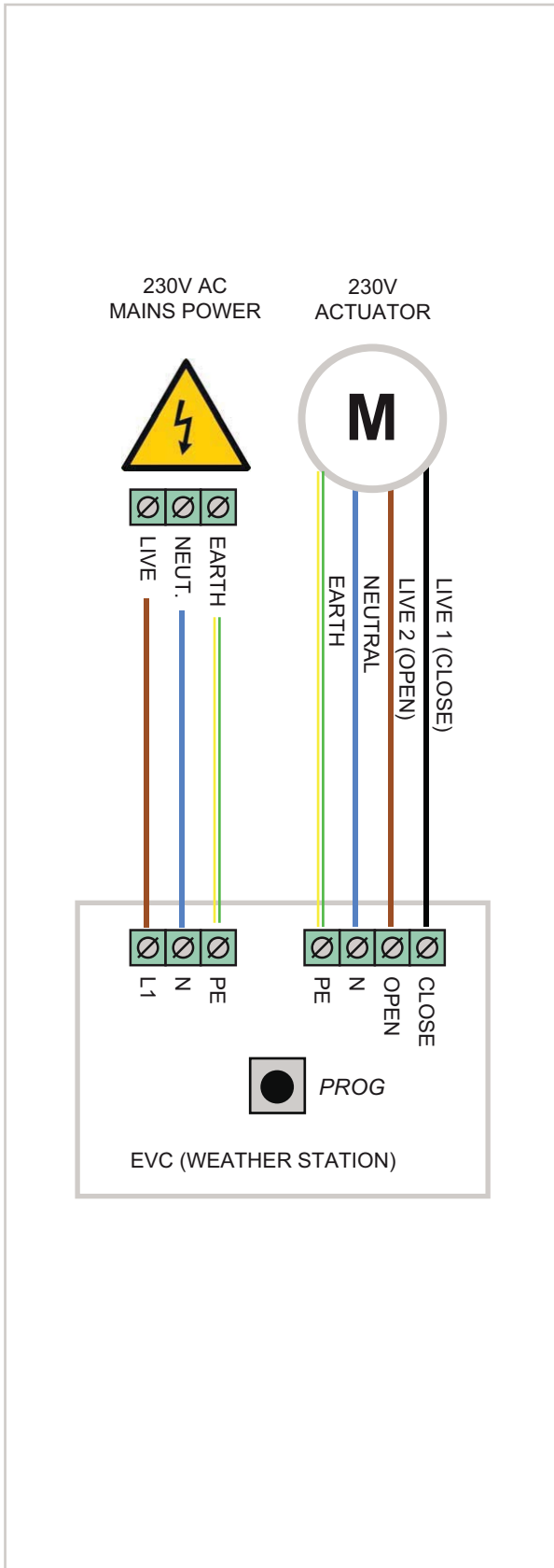

PLEASE NOTE

The installation of all electrical items must be undertaken by a qualified professional.

Do not use cable thicker than 1.5mm and multi-strand if possible for flexibility.

Wire all other inputs before connecting mains power.

PAIRING WEATHER STATION & CONTROL UNIT



- 1** Insert 2 x AA batteries inside the control unit.
- 2** Press and hold (SET) until you see the  symbol. Then again until you see CON.
- 3** Press (M/A) until you see LEA then press (SET). The control unit is now in pairing mode.
- 4** Turn on the power to the Weather Station then press the 'LEARN' button inside. The LED on the Weather Station will flash twice to confirm pairing.

PAIRING REMOTE TRANSMITTER (EVC-RC8)

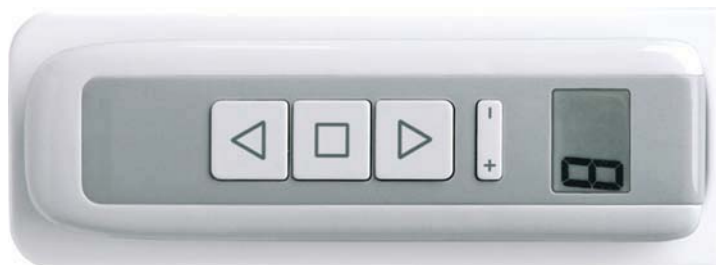
- 1** Press the centre of the +/- button on the hand-held transmitter until an "L" for Learn and a number (channel) are displayed.
- 2** Press + or - to select the channel you want to pair (L1 - L8).
- 3** Turn on the power to the Weather Station then press the 'LEARN' button inside. The LED on the Weather Station will flash twice to confirm pairing.





SETTING PARAMETERS

Press and hold  until you see the  symbol, you are now in the parameter settings menu. Press  to navigate through the different parameters.

Internal Temperature



Windows will automatically Open or Close to regulate the internal room temperature.

1 Use the   buttons to select the desired room temperature. Then press  to confirm your selection.

2 To turn off the Internal Temperature function adjust the temperature below 0°/OFF then press .

External Temperature



Windows will stay closed if external temperature is below the parameter set.

1 Use the   buttons to select the desired external temperature. Then press  to confirm your selection.

2 To turn off the External Temperature function adjust the temperature below -20°/OFF then press .



Rain Sensor

Windows will automatically close & remain closed for 5 mins. upon detection of rain.

1 Use the   buttons to turn the rain sensor function ON or OFF then press .

Wind Sensor

The windows will automatically close and remain closed for 5 mins. if the indicated Wind value is exceeded.

1 Use the   buttons to select the desired wind value. Then press  to confirm your selection.

2 To turn off the Wind Sensor function adjust the wind value below 0/OFF then press .

